



Steel Pressurized Tanks



APPLICATIONS

- Use wherever pressurized tanks are needed in water systems applications.

SPECIFICATIONS

Shell – Heavy gauge steel

Base – High-impact composite, ABS

Finish – Electrostatically applied, baked-on polyester paint

Water Cell – One piece seamless PVC, made from FDA listed material

Flange – Reinforced polypropylene

Service Connection – Reinforced polypropylene integral to flange

Air Valve – Rubber stem/brass body Schrader valve assembly

UV Valve Cover – High density polyethylene

ORDERING INFORMATION

Catalog Number	Maximum Capacity gal/liter	Diameter* inch/cm	Height* inch/cm	Length inch/cm	Precharge PSI/kPa	Connection Size Female	Drawdown in Gallons/Liter			Weight lbs/kg
							20-40	30-50	40-60	
VERTICAL MODELS										
PS6-S02	6.0 / 22.7	12 / 30.5	16.1 / 40.9	-	40 / 276	3/4" NPT	2.2 / 8.3	1.8 / 6.8	1.6 / 6.0	18 / 8.2
PS19S-T02	19 / 72	16 / 40.6	21 / 53.3	-	40 / 276	1" NPT	6.9 / 26.1	5.8 / 21.9	5.0 / 18.9	45 / 20.4
PS19T-T02	19 / 72	16 / 40.6	27.5 / 70	-	40 / 276	1" NPT	6.9 / 26.1	5.8 / 21.9	5.0 / 18.9	40 / 18.1
PS32-T03	32 / 122	20 / 51	43 / 109	-	40 / 276	1" NPT	11.6 / 43.9	9.8 / 37.1	8.5 / 32.2	56 / 25.4
PS35-T05	35 / 133	16 / 40.6	33 / 84	-	40 / 276	1" NPT	12.7 / 48.1	10.7 / 40.5	9.3 / 35.2	66 / 29.9
PS50-T50	50 / 189	20 / 51	32.5 / 83	-	40 / 276	1-1/4" NPT	18.3 / 69.3	15.5 / 58.7	13.4 / 50.7	84 / 38.1
PS62-T51	62 / 235	24 / 61	39.5 / 100	-	40 / 276	1-1/4" NPT	21.4 / 81.0	18.3 / 69.3	16.0 / 60.6	112 / 50.8
PS85-T52	85 / 322	24 / 61	51 / 130	-	40 / 276	1-1/4" NPT	30 / 113.6	26 / 98.4	22 / 83.3	124 / 56.2
PS119-TR50	119 / 450	24 / 61	68 / 173	-	40 / 276	1-1/4" NPT	41.3 / 156.3	35.4 / 134.0	31.0 / 117.3	140 / 63.5
IN-LINE VERTICAL MODELS										
PS2-S01	2.0 / 7.6	8.4 / 21.3	12.6 / 32.0	-	20 / 137.8	3/4" NPTM	0.7 / 2.65	0.6 / 2.2	NA	12.6 / 5.7
PS5-S02	5.0 / 18.9	10.6 / 26.9	16.2 / 41.1	-	30 / 206.8	3/4" NPTM	2.2 / 8.33	1.8 / 6.8	1.8 / 6.8	16.2 / 7.3
HORIZONTAL MODELS										
PS6H-S05	6.0 / 22.7	12 / 30.5	13.8 / 35.0	16 / 40.6	40 / 276	3/4" NPT	2.2 / 8.3	1.8 / 6.8	1.6 / 6.0	22 / 10
PS19H-S00	19 / 72	16 / 40.6	17.5 / 44.5	28 / 71.1	40 / 276	1" NPT	6.9 / 26.1	5.8 / 21.9	5.0 / 18.9	40 / 18

* Subject to change without notice.

Maximum Liquid Temperature: 120°F (49° C)

PRO-Source™ is a trademark of Pentair Water.

In order to provide the best products possible, specifications are subject to change.

Maximum Operating Pressure = 100 PSI

Maximum External (Ambient) Temperature: 125°F (52° C)



Steel Pressurized Tanks

FEATURES

Heavy Gauge Metal Construction –

Sturdy “welded wrapper and head design.” Built to last.

Polyester Paint Finish – Electrostatically powder painted, then oven baked for a smooth high-gloss, appliance-quality finish. Resists corrosion.

Elongated, Seamless Water Cell –

- Controlled 2-dimensional cell expansion.
- Rugged, seamless “water cell” prevents the most common cause of pump failure – “waterlogging.”
- Water never touches the steel tank material.
- Translucent bag material facilitates manufacturing quality control inspection.

Composite Sealing Flange –

- Corrosion-resistant.
- Integral o-ring groove better traps the water cell’s sealing ring.
- Reinforcing ribs strengthen and maintain a flat smooth sealing surface.

Integral Stand Pipe – Keeps the water cell standing erect, promoting complete flushing of the water entering/exiting the tank.

Nitrogen-Rich Precharge –

Decreases air permeation three to four times over straight air precharge.

40 PSI Precharge – Ready for use with 40/60 pressure range systems. Enables installer to reduce pressure depending on pressure switch setting.

Sturdy Base – Tested-tough composite construction.

TANK SIZING RULE:



Size tank for one gallon of drawdown for each gallon per minute at pump capacity.

EXAMPLE: For a 1 HP, 20 GPM unit pumping 20 gallons per minute on a 30-50 pressure switch setting, the properly sized PRO-Source™ tank is a PS85-T52 which has a 26 gallon drawdown.

CHART A – TANK SELECTION CHART

Pump GPM	System Pressure Switch Setting – PSI					
	20-40		30-50		40-60	
	Run Times					
	1 Minute	2 Minute	1 Minute	2 Minute	1 Minute	2 Minute
5	PS19T	PS32	PS19T	PS35	PS19T	PS35
7-1/2	PS32	PS35	PS32	PS50	PS32	PS62
10	PS32	PS62	PS35	PS62	PS35	PS85
12-1/2	PS35	PS62	PS50	PS85	PS50	PS85
15	PS50	PS85	PS50	PS50 (2)	PS62	PS62 (2)
20	PS62	PS62 (2)	PS62	PS62 (2)	PS85	PS85 (2)
30	PS285	PS85 (2)	PS50 (2)	PS85 (2)	PS62 (2)	PS85 (3)
30	–	–	PS119	PS119 + PS85	PS119	PS119 (2)
50	PS62 + PS85	PS85 (3)	PS85 (2)	PS85 (4)	PS85 (2)	PS85 (5)
50	–	PS119 (2) + PS62	–	PS119 (3)	PS119 (2)	PS119 (4)

NOTE: Drawdown will be affected by operating temperature of the system, accuracy of the pressure switch and gauge, the actual precharge pressure, and rate of fill. Pumps installed with a PRO-Source™ tank require a 100 PSI relief valve. Relief valve must be capable of relieving entire flow of pump at relief pressure.

CHART B – DRAWDOWN VOLUME MULTIPLIER* (APPROX.)

Pump Off Pressure PSI	Pump Start Pressure – PSI							
	10	20	30	40	50	60	70	80
20	0.26							
30	0.41	0.22						
40		0.37	0.18					
50		0.46	0.31	0.15				
60			0.40	0.27	0.13			
70			0.47	0.35	0.24	0.12		
80				0.42	0.32	0.21	0.11	
90				0.48	0.38	0.29	0.19	0.10
100					0.44	0.35	0.26	0.17

* Utilize this chart if proper selection cannot be made using Chart A. Drawdown based on Boyle’s Law.

- Procedure:** 1. Identify drawdown multiplier relating to specific application.
2. Insert multiplier (X) into the following formula:

$$\frac{\text{Pump GPM} \times \text{Min Run Time}}{\text{Multiplier (X)}} = \text{Minimum Tank Capacity Required}$$

Example: An example of a 20 GPM pump with a minimum run time of 1 minute, installed on a 50 - 70 PSIG system pressure range:

$$\frac{20 \text{ GPM} \times 1 \text{ Minute}}{.24 \text{ (factor) from Chart B}} = 83.3 \text{ minimum U.S. gal. tank capacity required}$$

Referring to “Ordering Information” chart, the model PS85-T52 has the closest U.S. gallon capacity that is greater or equal to the minimum volume requirement of 83.3 U.S. gallons.



Steel Pressurized Tanks

OPERATING CYCLE

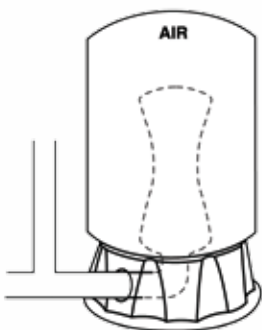

1. Separator is completely empty – A new cycle is ready to begin. Simple, positive action produces maximum drawdown on every cycle.

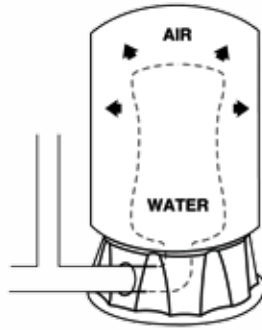

2. Water begins to enter the tank – Air is compressed around the water separator as it fills with water.

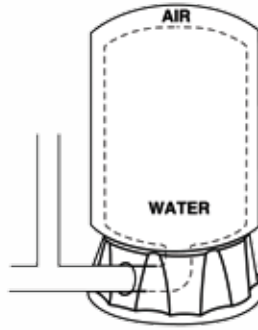

3. Pump up cycle completed – Air is now compressed to the cut-off setting of pressure switch.

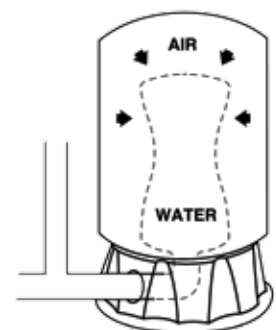

4. Water is being drawn from the tank – Compressed air in the tank forces water out of the separator.

ACCESSORIES

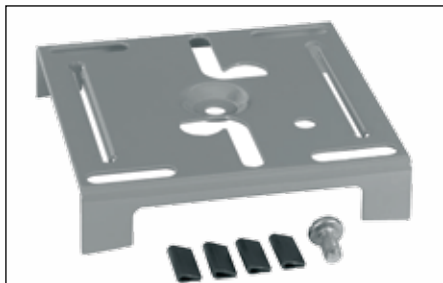

PKG 198
 Universal Jet
 Mounting
 Bracket

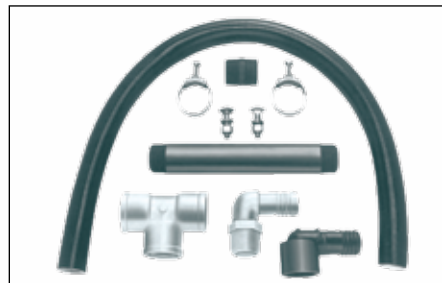

PKG 111,
 PKG 112 or
 PKG 207
 Jet Pump-to-Tank
 Mounting Pkg.

ORDERING INFORMATION

PKG 198 – Jet Pump Mounting Bracket

PKG 111 – Pump to Tank Fitting Package for composite jet pumps

PKG 112 – Pump to Tank Fitting Package for cast iron series jet pumps with composite fittings

PKG 207 – Pump to Tank Fitting Package for cast iron series jet pumps, with galvanized fittings

MULTIPLE TANK INSTALLATIONS

PRO-Source™ tanks can be connected together to increase the supply of usable water (drawdown). Two tanks of the same size will double the supply and three tanks will triple the supply. See Figures No. 1 and 2 for the typical installations of this kind.

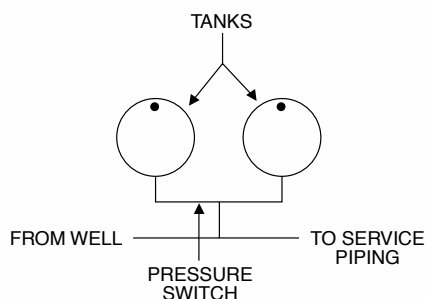

Figure 1

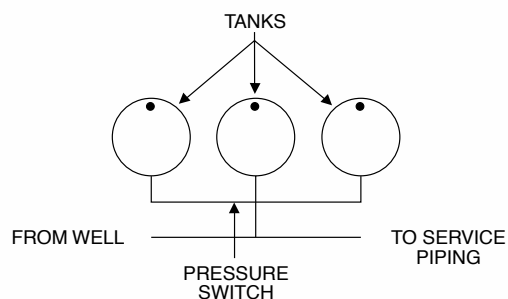
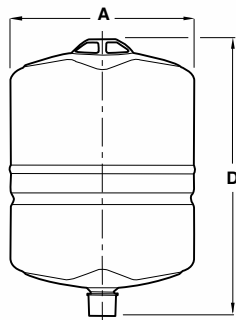
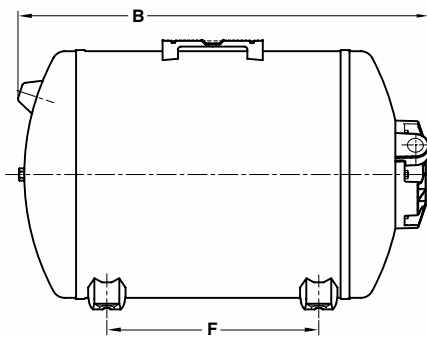

Figure 2



Steel Pressurized Tanks

OUTLINE DIMENSIONS



IN-LINE VERTICAL MODELS

Dimensions (in inches) are for estimating purposes only.

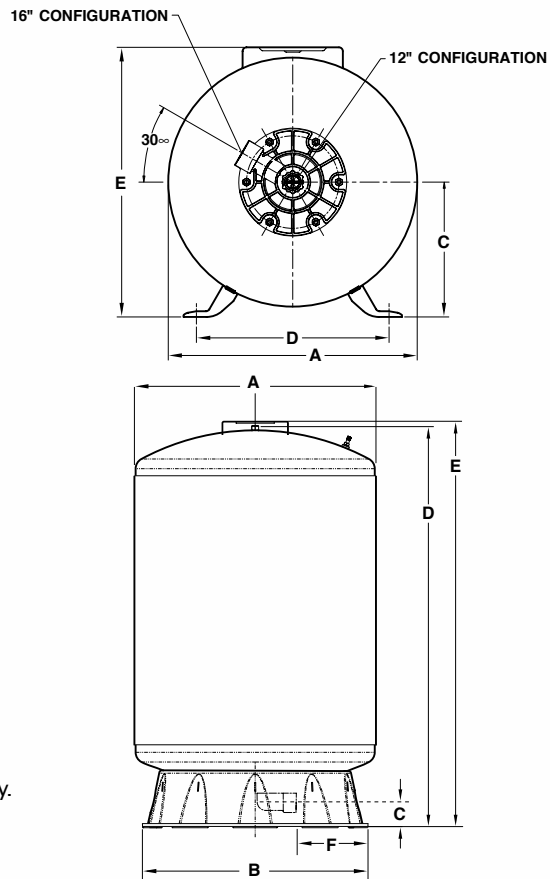

Catalog Number	Discharge NPT	A	B	C	D	E	F
VERTICAL MODELS							
PS6-S02	3/4"	12.0	-	-	16.1	-	-
PS19T-T02	1"	16.1	15.5	2.0	27.8	-	3.9
PS32-T03	1"	16.1	15.5	2.0	43.0	-	2.3
PS19S-T02	1"	20.1	15.5	2.0	-	21.5	2.3
PS35-T05	1"	20.1	15.5	2.0	33.0	-	2.3
PS50-T50	1-1/4"	24.1	22.7	2.5	33.2	-	5.5
PS62-T51	1-1/4"	24.1	22.7	2.5	40.1	-	5.5
PS85-T52	1-1/4"	24.1	22.7	2.5	51.5	-	5.5
PS119-TR50	1-1/4"	24.1	22.7	2.5	68.6	-	5.5
IN-LINE VERTICAL MODELS							
PS2-S01	3/4"	18.4	-	-	12.6	-	-
PS5-S02	3/4"	10.6	-	-	16.2	-	-
HORIZONTAL MODELS							
PS6H	3/4"	12.1	16.9	6.9	10.0	13.3	6.1
PS19H	1"	16.2	26.6	8.7	12.5	17.5	13.8



Steel Pressurized Tanks

SEQUENCE OF OPERATION

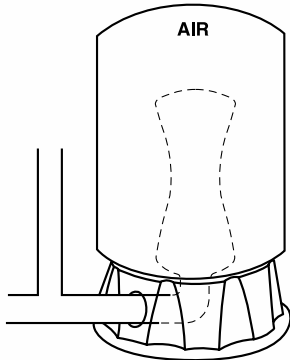

WATER CELL IS COMPLETELY EMPTY:
A new cycle is ready to begin. Simple, positive action produces maximum drawdown on every cycle.

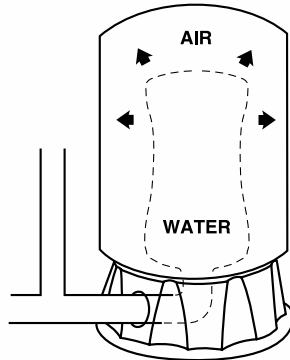

WATER BEGINS TO ENTER THE TANK:
Air is compressed around the water cell as it fills with water.

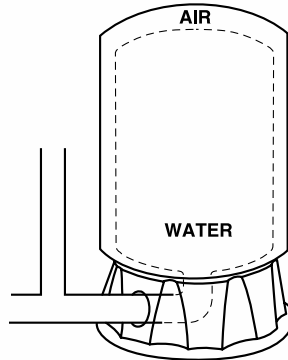

PUMP-UP CYCLE COMPLETED:
Air is now compressed to the cut-off setting of pressure switch.

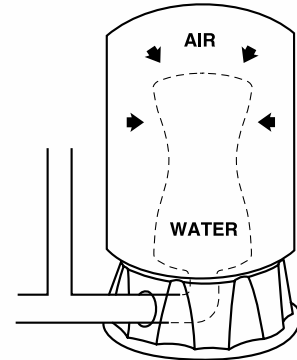

WATER IS BEING DRAWN FROM THE TANK: Compressed air in the tank forces water out of the water cell.